



TWENTIETH LOMONOSOV CONFERENCE August, 19-25, 2021 ON ELEMENTARY PARTICLE PHYSICS MOSCOW STATE UNIVERSITY

Tests of the Standard Model by means of $\Upsilon(3S)$ meson decays with the BABAR detector

Hossain Ahmed
St. Francis Xavier University
hahmed@stfx.ca

On behalf of the BaBar Collaboration



ST. FRANCIS XAVIER
UNIVERSITY

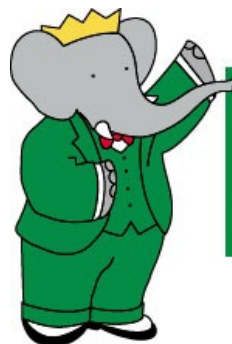

BABARTM

™ and © Nelvana, All Rights Reserved

Tests of the Standard Model by means of $\Upsilon(3S)$ meson decays with the BABAR detector

- Lepton Universality

- ✓ Precision Measurement of the Ratio $\mathcal{B}(\Upsilon(3S) \rightarrow \tau^+\tau^-) / \mathcal{B}(\Upsilon(3S) \rightarrow \mu^+\mu^-)$

Phys. Rev. Lett. 125, 241801 (2020) by BABAR Collaboration

- Charged Lepton Flavor Violation

- ✓ *Search for Lepton Flavor Violation in $\Upsilon(3S) \rightarrow e^\pm\mu^\mp$*

A journal (PRL) paper will be submitted in the near future

Motivation one

□ Lepton Universality

- In the SM, the branching fraction for the decay of $\Upsilon(nS) \rightarrow l^-l^+$ ($n = 1,2,3$ & $l = e, \mu, \tau$) is independent of the flavour of l excluding a tiny lepton mass effect
- Any deviation from the unity for the ratio of branching fractions would indicate the new physics
- Lepton Universality, therefore, is an excellent test of the SM prediction
- Leptonic decays of the $\Upsilon(nS)$ mesons are also important in search for phenomena beyond the SM

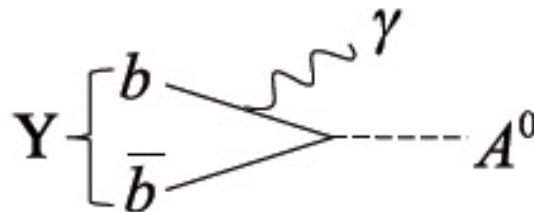

$A^0 \rightarrow cp \text{ odd} - \text{Higgs}$

Motivation two

□ Charged Lepton Flavor Violation (CLFV)

- Observation of mixing between the neutrino flavour eigenstate permits the CLFV in higher-order
- However, in the Standard Model (SM), CLFV is highly suppressed due to the small neutrino masses, e.g. $\left(\frac{\Delta m_\nu^2}{M_W^2}\right)^2$
- Observation of CLFV is, therefore, a clear sign of new physics (NP) beyond the SM

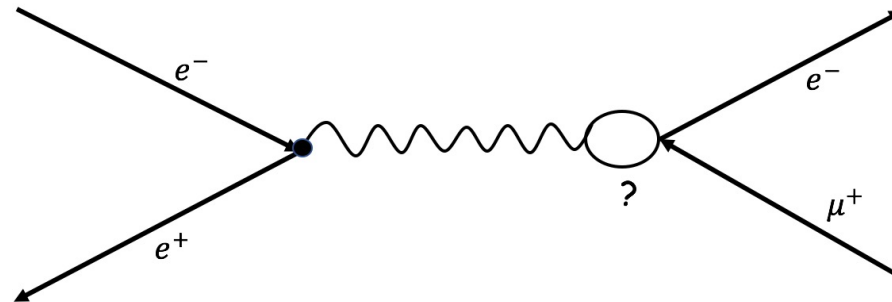

BaBar Detector

The BaBar Detector

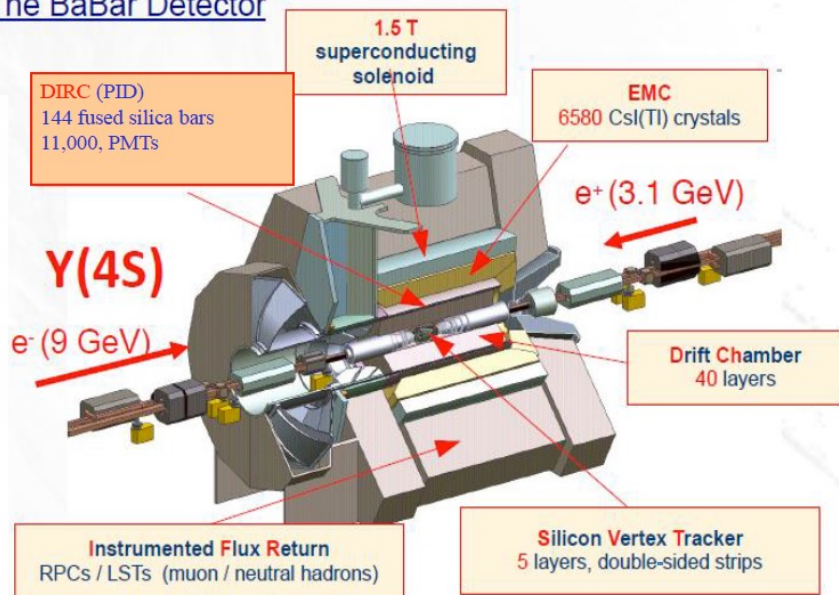

Between Dec. 2007 – Apr. 2008, BaBar collected data below $\Upsilon(4S)$

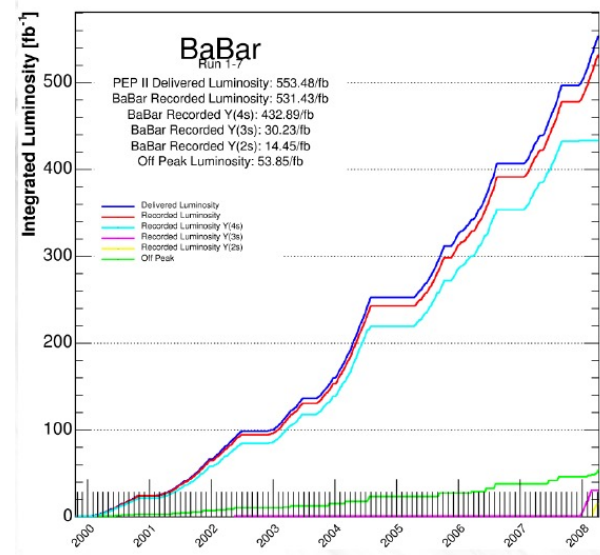
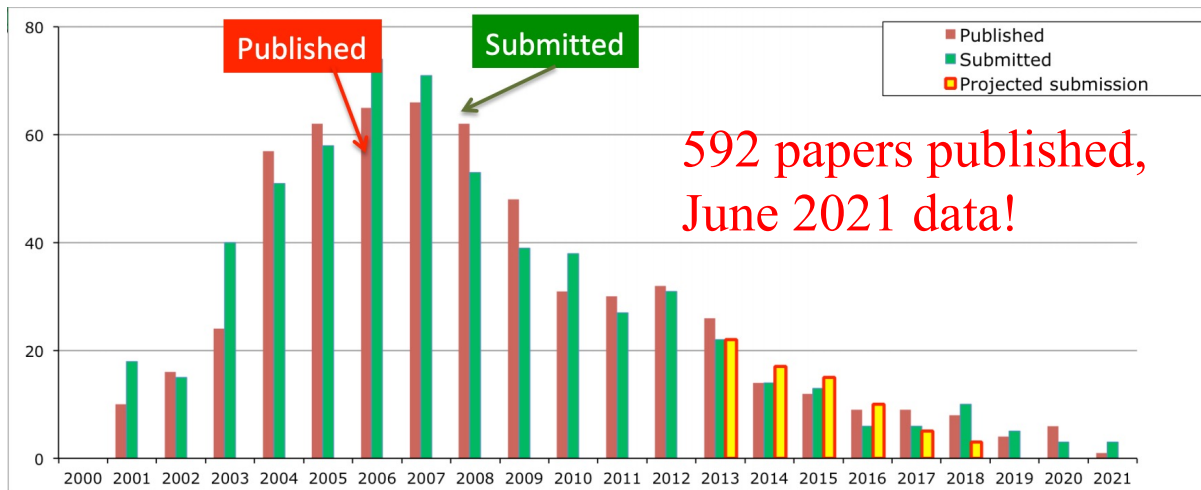
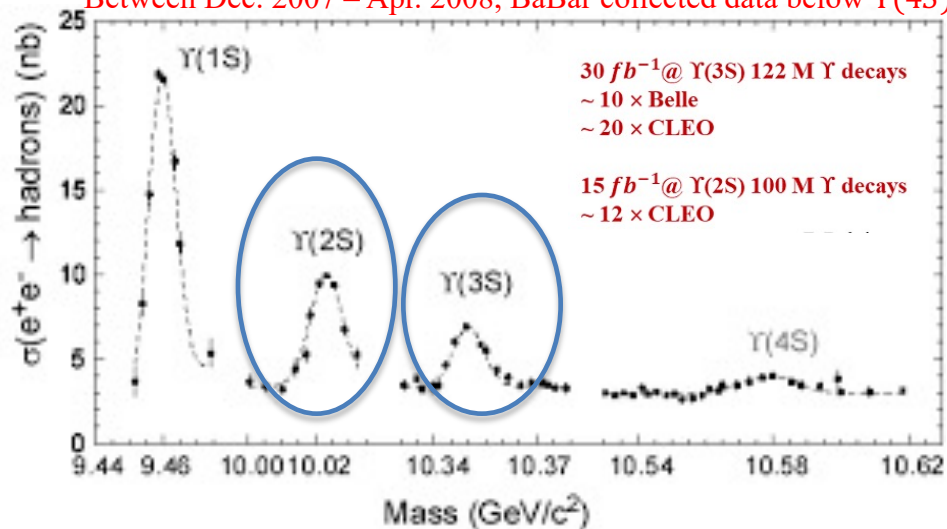

Analysis Modes

Lepton Universality

$$B(\Upsilon(3S) \rightarrow \tau^+ \tau^-) / B(\Upsilon(3S) \rightarrow \mu^+ \mu^-)$$

- 27.96 fb⁻¹ $\Upsilon(3S)$ on-peak data
- 78.3 fb⁻¹ $\Upsilon(4S)$ on-peak data and
- 7.75 fb⁻¹ $\Upsilon(4S)$ off-peak data (40 MeV below the on-peak) and
- 2.62 fb⁻¹ $\Upsilon(3S)$ off-peak data (40 MeV below the on-peak) as control samples
- **Control samples are used to evaluate properties of background, to study systematic effects, and to calculate corrections to MC based efficiencies!**

CLFV

$$\Upsilon(3S) \rightarrow e^\pm \mu^\mp$$

- 27.9 fb⁻¹ $\Upsilon(3S)$ on-peak data
- 78.31 fb⁻¹ $\Upsilon(4S)$ on-peak data for systematic studies (data driven continuum background)
- 2.62 fb⁻¹ $\Upsilon(3S)$ off-peak data (40 MeV below the on-peak) and
- 7.75 fb⁻¹ $\Upsilon(4S)$ off-peak data (40 MeV below the on-peak) to validate the systematic studies
- **MC signal: $e^+ e^- \rightarrow \Upsilon(3S) \rightarrow e^\pm \mu^\mp$: 103000 events**

Lepton Universality

$B(\Upsilon(3S) \rightarrow \tau^+\tau^-)/B(\Upsilon(3S) \rightarrow \mu^+\mu^-)$ **Phys. Rev. Lett. 125, 241801**

❖ Monte Carlo (MC) samples:

- Continuum: $\tau^+\tau^-$, $\mu^+\mu^-$, *Bhabhas*, *uds*, $c\bar{c}$ ($\sqrt{s} = m_{\Upsilon(3S)}$ and $\sqrt{s} = m_{\Upsilon(4S)}$)
 - $\tau^+\tau^-$, $\mu^+\mu^-$ -- KKMC (with radiative effects)
 - Bhabhas –BHWIDE
 - Hadronic continuum and generic $\Upsilon(3S)$ – EvtGen (PHOTOS)
- $\Upsilon(3S) \rightarrow \tau^+\tau^-$, $\mu^+\mu^-$ signal events – KKMC (ISR turned off) – Signal MC sample is about three times the size of the data sample
- GEANT4 for detector acceptance

❖ Event selections:

- two oppositeley charged tracks (each in one hemisphere)

$\mu^+\mu^-$

- At least one μ hit IFR (suppressing Bhabha)
- $0.8 < M_{\mu\mu}/\sqrt{s} < 1.1$
- 99.9% purity

$\tau^+\tau^-$

- One track is required to be identified as an electron (based on PID) and the other doesn't
- Angle between two track in the center-of-mass $> 110^\circ$
- $|\cos\theta_{miss}| < 0.85$ in the center-of-mass frame
- 98.9 % purity

Lepton Universality

$B(Y(3S) \rightarrow \tau^+\tau^-)/B(Y(3S) \rightarrow \mu^+\mu^-)$ **Phys. Rev. Lett. 125, 241801**

□ Data Analysis

- Off-resonance data ($Y(4S), Y(3S)$) are used to correct the differences between MC and data ($\tau^+\tau^- / \mu^+\mu^-$) selection efficiency ratios
- Continuum modeling:

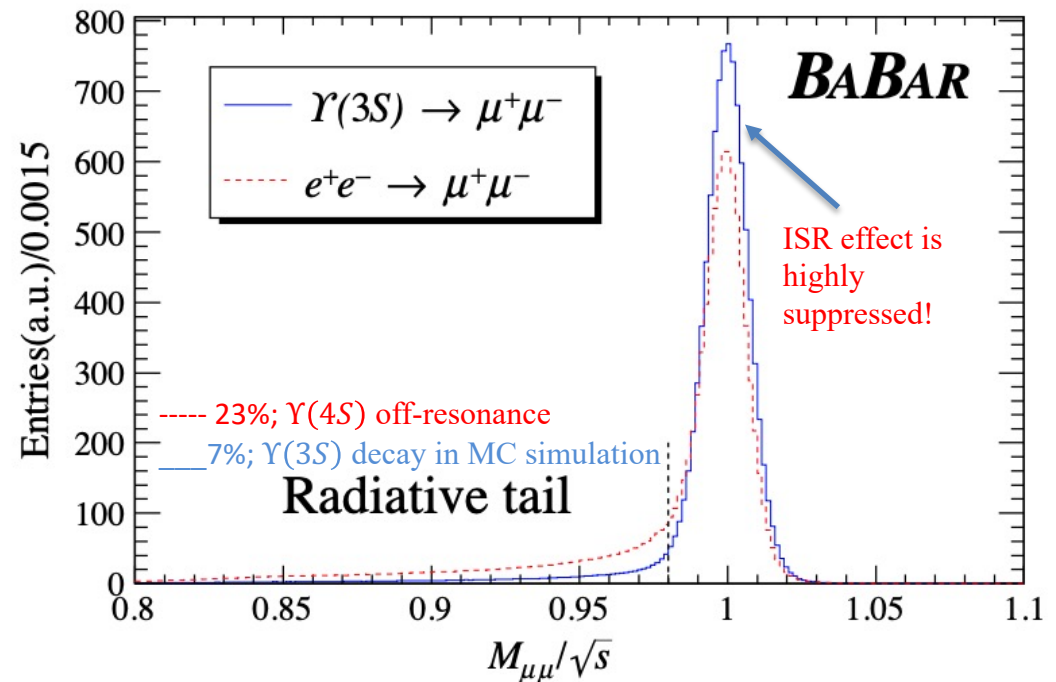

- For the $\tau^+\tau^-$ events the total reconstructed event energy scaled to the center-of-mass energy $E_{\tau\tau}/\sqrt{s}$ is plotted
- Cascade decays are considered (via radiative and hadronic transitions)

Lepton Universality

$B(Y(3S) \rightarrow \tau^+\tau^-)/B(Y(3S) \rightarrow \mu^+\mu^-)$ **Phys. Rev. Lett. 125, 241801**

□ Data Analysis: Fitting

- To extract the ratio $\mathcal{R}_{\tau\mu}^{Y(3S)}$, a binned maximum likelihood fit is employed on $M_{\mu\mu}/\sqrt{s}$ and $E_{\tau\tau}/\sqrt{s}$
- $Y(3S) \rightarrow \mu^+\mu^-$ and $Y(3S) \rightarrow \tau^+\tau^-$ are taken from KKMC (no ISR)
- $Y(2S) \rightarrow l^+l^-$, $Y(1S) \rightarrow l^+l^-$, and $Y(nS) \rightarrow hadrons$ are from EvtGen MC

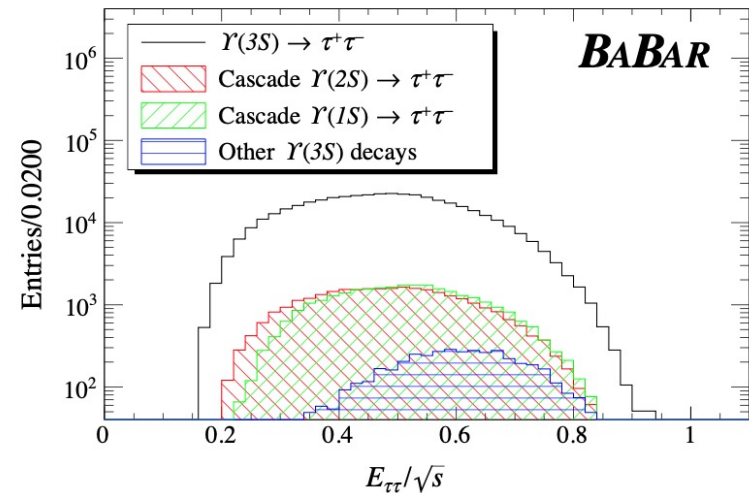
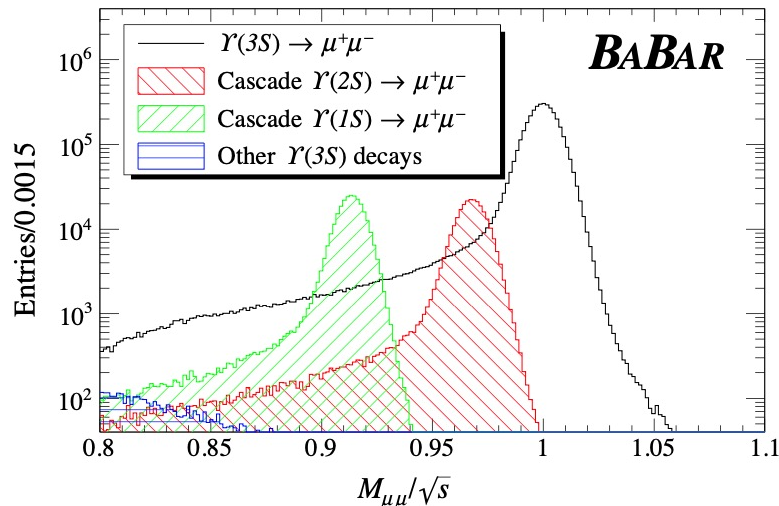

- Cascade decays are clearly separated in dimuon events and nearly indistinguishable in $\tau^+\tau^-$ events.
- Continuum templates are then use data control samples: $Y(4S)$ run6 data

Lepton Universality

$B(\Upsilon(3S) \rightarrow \tau^+\tau^-)/B(\Upsilon(3S) \rightarrow \mu^+\mu^-)$ **Phys. Rev. Lett. 125, 241801**

□ Data Analysis: Fit Result

- $M_{\mu\mu}/\sqrt{s}$ and $E_{\tau\tau}/\sqrt{s}$ are simultaneously fit using MC and data derived templates
- The free parameters of the fit are the number of $\Upsilon(3S) \rightarrow \mu^+\mu^-$ events

$$N_{\mu\mu} \text{ and the raw ratio } \tilde{R}_{\tau\mu} = \frac{N_{\tau\tau}}{N_{\mu\mu}}$$

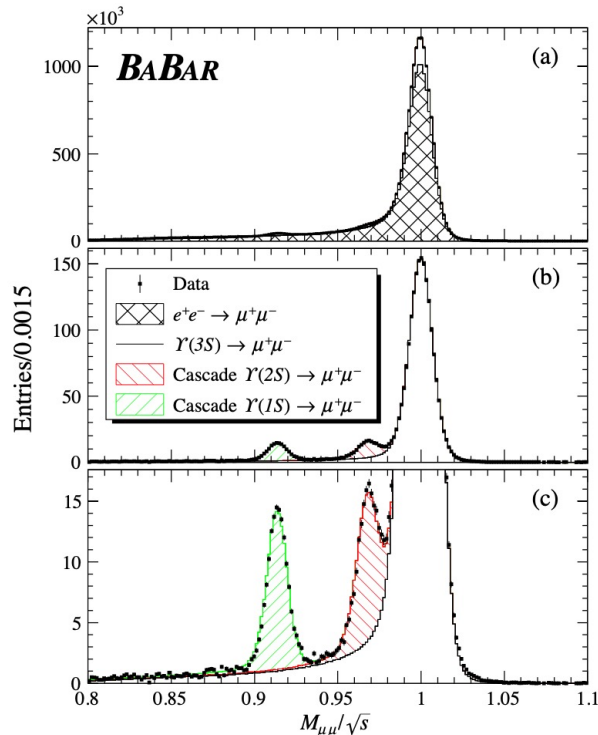

■ Systematics:

Source	Uncertainty (%)
Particle identification	0.9
Cascade decays	0.6
Two-photon production	0.5
$\Upsilon(3S) \rightarrow$ hadrons	0.4
MC shape	0.4
$B\bar{B}$ contribution	0.2
ISR subtraction	0.2
Total	1.4

Lepton Universality

$B(Y(3S) \rightarrow \tau^+\tau^-)/B(Y(3S) \rightarrow \mu^+\mu^-)$ **Phys. Rev. Lett. 125, 241801**

□ Data Analysis: Fit Result

$$\mathcal{R}_{\tau\mu}^{Y(3S)} = \tilde{R}_{\tau\mu} \frac{1}{C_{\text{MC}}} \frac{\epsilon_{\mu\mu}}{\epsilon_{\tau\tau}} (1 + \delta_{B\bar{B}})$$

- $\tilde{R}_{\tau\mu}$ is the fit result, C_{MC} is the data/MC correction, $\epsilon_{\mu\mu}/\epsilon_{\tau\tau}$ is the MC selection efficiency, and $\delta_{B\bar{B}}$ is the correction from $B\bar{B}$ events
- Using $Y(3S)$ data with $Y(4S)$ and off-resonance control samples BaBar measures the ratio of the leptonic branching fractions of the $Y(3S)$ meson

$$\begin{aligned} \text{is: } \mathcal{R}_{\tau\mu}^{Y(3S)} &= \frac{B(Y(3S) \rightarrow \tau^+\tau^-)}{B(Y(3S) \rightarrow \mu^+\mu^-)} = 0.966 \pm 0.008_{\text{stat}} \pm 0.014_{\text{syst}} \\ &= 0.966 \pm 0.016_{\text{tot}} \end{aligned}$$

- Six times more precise than the CLEO measurement [**PRL 98, 052002 (2007)**]
- The final ratio is with 2σ of the SM value 0.9948 [**J. High Energy Phys. 06 (2017) 019**]

Charged Lepton Flavor Violation

$$\Upsilon(3S) \rightarrow e^\pm \mu^\mp$$

S. Nussinov, et. al.
Phys.Rev. D63 (2001) 016003

□ Theory:

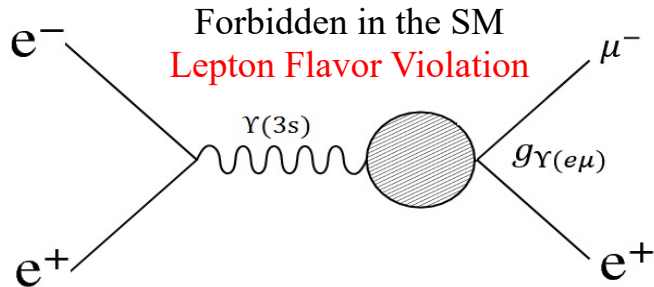

Re-ordering
incoming/outgoing particles

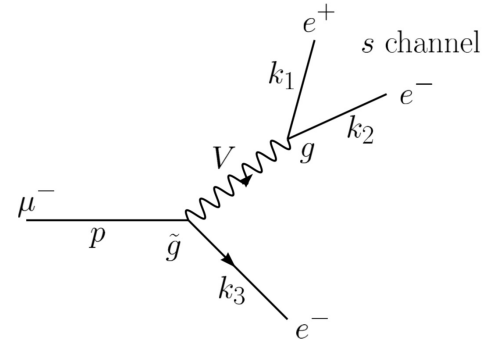

- Compare the re-ordered diagram with the ordinary Muon decay

$$\frac{\Gamma(\mu \rightarrow 3e)_{V\text{-exchange}}}{\Gamma(\mu \rightarrow e\nu\bar{\nu})} \approx [BR(\mu \rightarrow 3e)]_{V\text{-exch.}} \approx \frac{\Gamma(V \rightarrow e^+e^-)\Gamma(V \rightarrow e^\pm\mu^\mp)}{\Gamma^2(W \rightarrow e\nu)} \left(\frac{M_W}{M_V}\right)^6$$

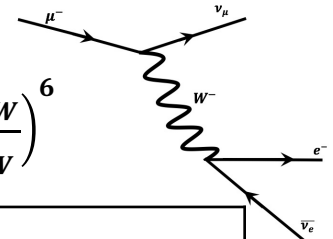

Existing Measurements	Results	CL (%)	Collaboration
$BF(\Upsilon(3S) \rightarrow e^\pm \tau^\mp)$	$< 4.2 \times 10^{-6}$	90	J.P. Lees et al. PR D89 111102 [BaBar Collaboration]
$BF(\Upsilon(3S) \rightarrow \mu^\pm \tau^\mp)$	$< 3.1 \times 10^{-6}$	90	
$BF(\Upsilon(3S) \rightarrow \mu^\pm \tau^\mp)$	$< 20.3 \times 10^{-6}$	95	Love et al. PRL 101, 201601 [CLEO Collaboration]

- No published experimental measurement of the decay on $\Upsilon(3S) \rightarrow e^\pm \mu^\mp$ yet!

Charged Lepton Flavor Violation

$$\Upsilon(3S) \rightarrow e^\pm \mu^\mp$$

□ Data Analysis: selection and reconstruction

- two oppositely charged tracks (directly from $\Upsilon(3S) \rightarrow$ signal candidates!)
- momentum close to beam energy
 $(E_B = \frac{\sqrt{s}}{2})$
- angle between two tracks: $\theta_{12}^{CM} > 179^\circ$
- energy deposit by muons on EMC > 50 MeV
- EMC acceptance $24^\circ < \theta_{Lab} < 130^\circ$
- main sources of backgrounds: $e^+e^- \rightarrow \tau^+\tau^-, \mu^+\mu^-(\gamma), e^+e^-(\gamma)$
- in second stage tighter and optimized particle identification (PID) and kinematics criteria applied, i.e. lepton momentum plane

$$\left(\frac{p_e}{\sqrt{s} * 0.5} - 1\right)^2 + \left(\frac{p_\mu}{\sqrt{s} * 0.5} - 1\right)^2 < 0.01$$

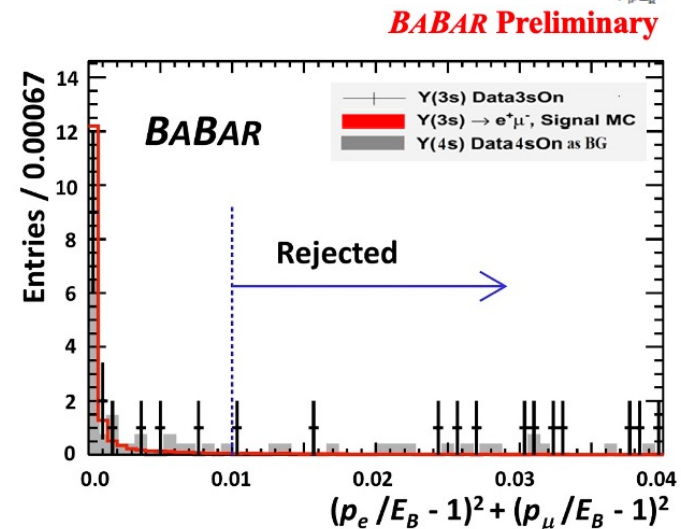
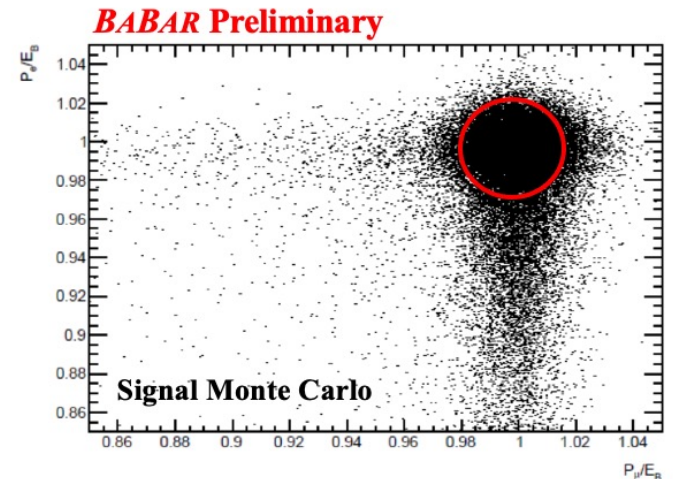

Charged Lepton Flavor Violation

$$\Upsilon(3S) \rightarrow e^\pm \mu^\mp$$

□ Data Analysis: results

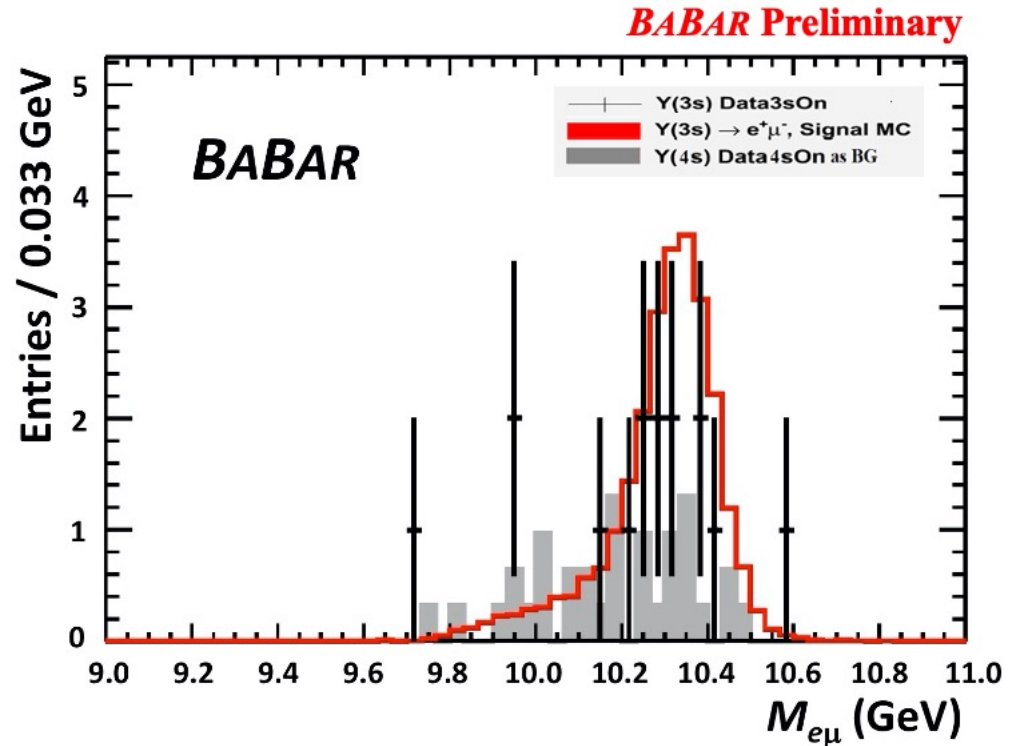
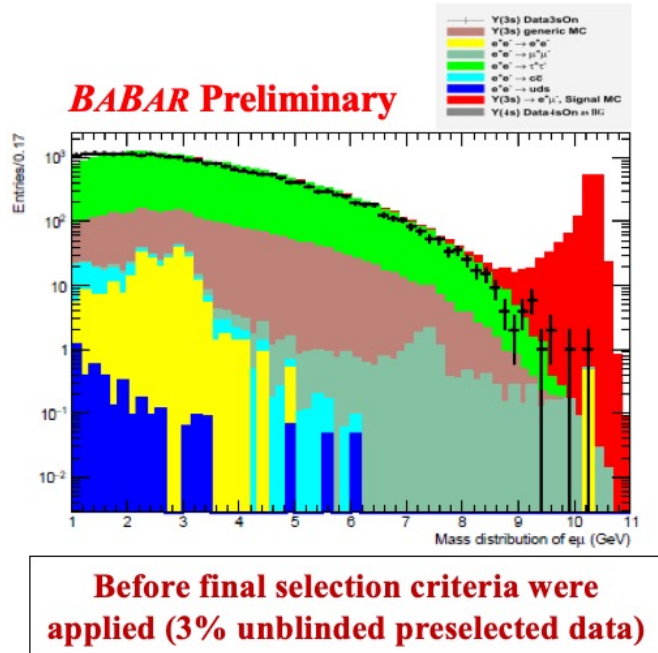

- **Branching Fraction:** $\frac{N_{\text{Candidate}} - N_{\text{BG}}}{\epsilon_{\text{sig}} \times N_{\Upsilon}} = (1.0 \pm 1.4_{\text{stat}(N_{\text{Candidate}})} \pm 0.8_{\text{syst}}) \times 10^{-7}$
- **Set an upper limit at 90% confidence level:** $B(\Upsilon(3S) \rightarrow e^\pm \mu^\mp) < 3.6 \times 10^{-7} @ 90\% \text{ CL}$
[J.Phys.G 28 (2002) 2693-2704]
- **Paper is now in final preparation for PRL**

Summary

- BABAR has made a significant contribution to Lepton Universality search by $\mathcal{B}(\Upsilon(3S) \rightarrow \tau^+\tau^-)/\mathcal{B}(\Upsilon(3S) \rightarrow \mu^+\mu^-)$ and verify the SM prediction
 - the result is six times precise than the only previous measurement by CLEO.
 - result published in **Phys. Rev. Lett. 125, 241801**
- No significant evidence for Charged Lepton Flavor Violation in $\Upsilon(3S) \rightarrow e^\pm\mu^\mp$ decay and an upper limit has been set.

Backup Slides (LU)

- Extended van Royen–Weisskopf formalism for lepton–antilepton meson decay widths:

$$\Gamma_{\Upsilon \rightarrow \ell\ell} = 4\alpha^2 e_q^2 \frac{|\Psi(0)|^2}{M^2} (1 + 2m_\ell^2/M^2) \sqrt{1 - 4m_\ell^2/M^2} \quad (1)$$

$$R_{\tau\mu} = \frac{\Gamma_{\Upsilon \rightarrow \tau\tau}}{\Gamma_{\Upsilon \rightarrow \mu\mu}} = \frac{(1 + 2m_\tau^2/M^2) \sqrt{1 - 4m_\tau^2/M^2}}{(1 + 2m_\mu^2/M^2) \sqrt{1 - 4m_\mu^2/M^2}} \quad (2)$$

☐ Muon selection: more

- Polar angle of the negative muon must be in the range $0.65 < \theta_- < 2.5$ radians in the center of mass frame
- Polar angle of the positive muon must be in the range $0.58 < \theta_+ < 2.56$ radians in the center of mass frame
- Open angle between muons must be $\Psi > 160^\circ$ in the center of mass frame

Backup Slides (LU)

□ Tau selection: more

- Polar angle of the particles must be in the range $41^\circ < \theta_{\pm} < 148^\circ$ radians in the center of mass frame
- Open angle between must be $\Psi > 110^\circ$ in the center of mass frame
- Total energy deposition must be $< 0.7 \times E_{ini}$. Where E_{ini} is the initial energy in the laboratory frame
- Acollinearity of azimuthal angles of the particles must be $|\phi_+ - \phi_-| - 180^\circ > 3^\circ$
- Missing mass of an event must be $|M_{miss}^2| > 0.01 \times s$
- Polar angle of the missing momentum vector must be $|\cos \theta_{miss}| < 0.85$ in the center-of-mass frame
- $|\Delta\phi| = ||\phi_{e\gamma} - \phi_{\ell}| - 180^\circ| > 2^\circ$ and $|\Delta\theta| = ||\theta_{e\gamma} - \theta_{\ell}| - 180^\circ| > 2^\circ$

Backup Slides (CLFV)

❖ Monte Carlo (MC) samples:

- Continuum: $\tau^+\tau^-$, $\mu^+\mu^-$, *Bhabhas*, *uds*, $c\bar{c}$ ($\sqrt{s} = m_{\Upsilon(3S)}$ and $\sqrt{s} = m_{\Upsilon(4S)}$)
 - $\tau^+\tau^-$, $\mu^+\mu^-$ -- KKMC (with radiative effects)
 - Bhabhas –BHWIDE
 - Hadronic continuum and generic $\Upsilon(3S)$ – EvtGen (PHOTOS)

❖ Limit of New Physics (NP):

- This result is the first reported experimental upper limit on its kind
- It can be interpreted as a limit on NP using the relationship:

$$\left(\frac{g_{NP}^2}{\Lambda_{NP}}\right)^2 / \left(\frac{4\pi\alpha_{QED}Q_b}{M_{\Upsilon(3S)}}\right)^2 = \frac{BF(\Upsilon(3S) \rightarrow e\mu)}{BF(\Upsilon(3S) \rightarrow \mu\mu)}$$

$$\Lambda_{NP}/g_{NP}^2 \geq \mathbf{80 \text{ TeV @90\% CL}}$$

Backup Slides (CLFV)

❖ Systematics

TABLE II: Summary of systematic uncertainties. The values of the efficiency, background, and number of $\Upsilon(3S)$ decays are presented in the first column and their uncertainties in the second column. The different contributions to the efficiency systematic uncertainties are also presented.

Component Value	Uncertainties by Source
Signal Efficiency: 0.2342	Lep. Mom. cut: 0.0068 (2.9 %)
	Back-to-back cut: 0.0026 (1.1 %)
	All other cuts: 0.0028 (1.2 %)
	MC statistics: 0.0003 (0.13 %)
	± 0.0078 (3.3 %)
$N_{\Upsilon}: 117.7 \times 10^6$	$\pm 1.2 \times 10^6$ (1.0 %)
BG: 12.2	± 2.3 (19 %)